



OMEGA

OMEGA

Ω
OMEGA

1/8

OPERATING INSTRUCTIONS

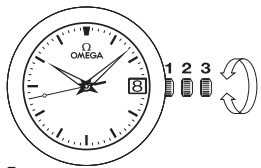

I

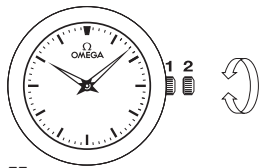

II

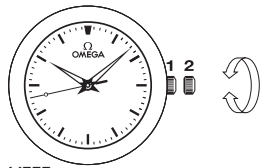

VIII

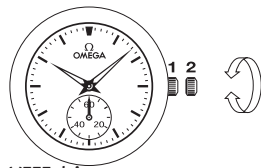

VIII bis

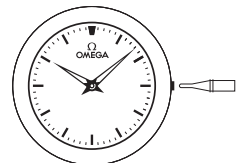

II bis

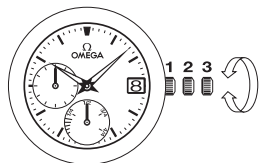

III

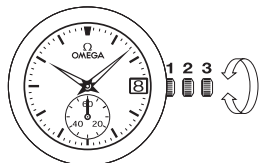

IX



IV

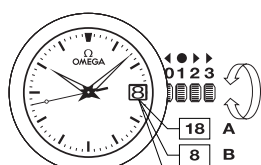

V

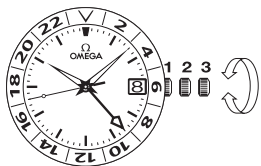

VI

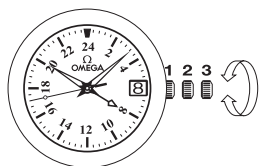

VII

Small second
 Petite seconde
 Pequeño segundero
 Kleine Sekundenanzeige
 Piccoli secondi
 小秒針
 스톨 세컨드
 小秒針指示圓盤
 小秒針指示圓盤
 عداد الثواني الصغير



Hours counter
 Compteur heures
 Contador de horas
 Stundenzähler
 Contatore delle ore cronografiche
 時間積算計
 시간계
 小時指示圓盤
 小時指示圓盤
 عداد الساعات



Minutes counter
 Compteur minutes
 Contador de minutos
 Minutenzähler
 Contatore dei minuti cronografici
 分鐘積算計
 분계
 分鐘指示圓盤
 分鐘指示圓盤
 عداد الدقائق

Chronograph seconds
 Seconde chronographe
 Segundero de cronógrafo
 Chronographsekunde
 Secondi cronografici
 クロノグラフ秒針
 크로노그래프 세컨드
 計時秒針
 計時秒針
 كرونوغراف الثواني

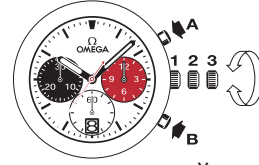

X

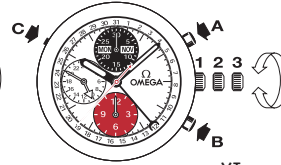

XI

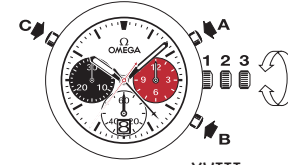

XVIII

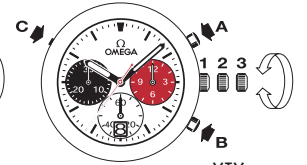

XIX

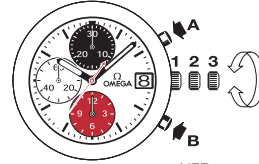

XII

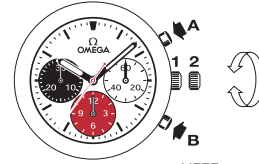

XIII

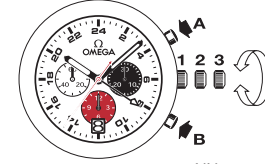

XX

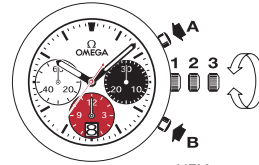

XIV

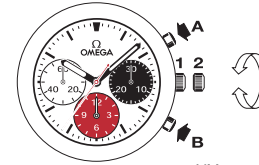

XV

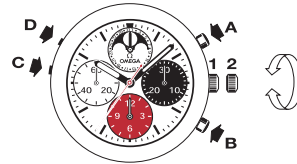

XVI

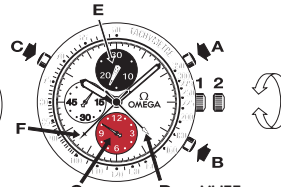

XVII

1 INTRODUCTION

- Special recommendations 4
- Environmental protection 5
- Leather straps 5
- Anti-reflective treatment 6
- Screw-in crown 6
- OMEGA International Warranty 7

2 OPERATING INSTRUCTIONS

- **Quartz watch** 11
Cal. 1376 • 1424 • 1426 • 1456 • 1530 • 1532 • 1538 • 4000
- **Quartz Chronograph** Cal. 1270 • 5200 13
- **Manual & Self-winding watch** 16
Cal. 1120 • 2005 • 2200 • 2201 • 2202 • 2300 • 2403 • 2500 • 2520 • 2610 • 2627
- **Self-winding chronograph** 18
Cal. 1151 • 1152 • 1164 • 3205 • 3220 • 3301 • 3303 • 3304 • 3313 • 3601 • 3602
- **Self-winding split-seconds chronograph** 21
Cal. 3600 • 3612
- **Manual-winding chronograph** 23
Cal. 1861 • 1863 • 1866 • 3604
- **Perpetual calendar** Cal. 1680 25
- **Self-winding GMT & GMT Chronograph** 28
Cal. 1128 • 2628 • 3603

3 PRECISION TOLERANCES

- Mechanical watches • Quartz watches 31

4 SPECIFIC SECTIONS/GENERAL INFORMATION

- Helium escape valve 33
- Tachymeter scale 35
- Rubber strap 36
- Foldover clasps 38
- Pictograms 40

Special recommendations

What must I do to ensure that my OMEGA watch provides me with excellent service for many years?

Magnetic fields: avoid placing your watch on loudspeakers or refrigerators, since they generate powerful magnetic fields.

Swimming in the sea: always rinse your watch with warm water afterwards.

Shocks: whether thermal or other, avoid them.

Screw-in crown: screw in the crown carefully to prevent water from penetrating the mechanism.

Non screw-in crown: push it back into the neutral position to prevent water from entering the mechanism.

Cleaning: for metal bracelets and water-resistant cases, use a toothbrush with soapy water to clean and a soft cloth for drying.

Chemical products: avoid direct contact with solvents, detergents, perfumes, cosmetics etc., since they may damage the bracelet, case or gaskets.

Temperature: avoid exposure to extreme temperatures (greater than 60°C, or 140°F, less than 0°, or 32°F) or extreme temperature changes.

Water resistance: a watch's water resistance cannot be permanently guaranteed. It may be affected by ageing of gaskets or by an accidental shock to the crown. As stipulated in our service instructions, we recommend you have the water resistance of your watch checked once a year by an approved OMEGA service agent.

Chronograph push-pieces: Do not operate chronograph pushers under water in order to prevent water entering the mechanism.

Exception: The Seamaster 300 m Chronographs have pushers which can function under water.

What are the service intervals?

Like any precision instrument, a watch needs regular servicing to ensure that it functions perfectly. We cannot indicate the frequency of such work, since it depends

Special recommendations

entirely on the model, the climate and the owner's individual care of the watch. As a general rule, a watch should be serviced every 4 to 5 years, depending on the conditions in which it is used.

Who should I contact for a maintenance service or battery replacement?

We recommend that you contact an approved OMEGA service centre or authorised OMEGA retailer, who are the only entities equipped with the tools and apparatus required to carry out the work and the necessary checks in a professional manner. Furthermore, only these entities can guarantee that their work is carried out in accordance with OMEGA's strict quality standards.

Environmental protection

Used batteries, watch components and electronic watches should not be thrown away. They should be recycled correctly. We recommend you return them to your nearest OMEGA retailer.



Leather straps

OMEGA recommends that you follow the steps below in order to preserve the condition of your leather strap for as long as possible:

- Avoid contact with water and dampness to prevent discoloration and deformation.
- Avoid prolonged exposure to sunlight to prevent the colour from fading.
- Do not forget that leather is permeable! Therefore avoid contact with greasy substances and cosmetic products.
- If you have a problem with your leather strap, please contact your nearest OMEGA retailer.

Anti-reflective treatment



The anti-reflective treatment on both sides of the sapphire crystal improves the visibility of your watch's dial. Wear and tear may cause marks to appear. These are considered normal and are therefore not covered by the warranty.

6

Screw-in crown



Some watches are fitted with a screw-in crown which should be unscrewed before use. After use, push the crown into position 1 then press and screw back in (water-resistance).

OMEGA International Warranty

(Valid for U.S.A. only)

Your OMEGA® watch is warranted by OMEGA SA* FOR A PERIOD OF TWENTY-FOUR (24) MONTHS, THIRTY-SIX (36) MONTHS FOR WATCHES WITH A CO-AXIAL ESCAPEMENT, FROM THE DATE OF PURCHASE under the terms and conditions of this warranty. The international OMEGA warranty covers material and manufacturing defects existing at the time of delivery of the purchased OMEGA watch ("defects"). The warranty only comes into force if the warranty certificate is dated, fully and correctly completed and stamped by an official OMEGA dealer ("valid warranty certificate").

During the warranty period and by presenting the valid warranty certificate, you will have the right to have any defect repaired free of charge. In the event that repairs are unable to restore the normal conditions of use of your OMEGA watch, OMEGA SA guarantees its replacement by an OMEGA watch of identical or similar characteristics. The warranty for the replacement watch ends twenty-four (24) months, thirty-six (36) months for watches with a Co-Axial Escapement, after the date of purchase of the replaced watch.

This manufacturer's warranty does not cover:

- the life of the battery;
- normal wear and tear and aging (e.g. scratched crystal; alteration of the colour and/or material of non metallic straps and chains, such as leather, textile, rubber);
- any damage on any part of the watch resulting from abnormal/abusive use, lack of care, negligence, accidents (knocks, dents, crushing, broken crystal, etc.), incorrect use of the watch and non-observance of the use directions provided by OMEGA SA;

OMEGA International Warranty

- the OMEGA watch handled by non-authorized persons (e.g. for battery replacement, service or repair) or which has been altered in its original condition beyond OMEGA SA's control.

8

ALL APPLICABLE IMPLIED WARRANTIES, INCLUDING THE IMPLIED WARRANTY OF MERCHANTABILITY AND OF FITNESS FOR A PARTICULAR PURPOSE GIVEN TO YOU BY LAW ARE HEREBY LIMITED IN DURATION TO THE DURATION OF THIS WARRANTY. UNDER NO CIRCUMSTANCES WILL OMEGA SA BE LIABLE FOR ANY INDIRECT OR CONSEQUENTIAL DAMAGES OF ANY KIND.

Some states do not allow limitations on how long implied warranties last, or exclusions or limitations of incidental or consequential damages, so exclusions or limitations mentioned may not apply to you. This warranty gives you specific legal rights and you may also have other rights which may vary from state to state.

OMEGA SA's OBLIGATION IS STRICTLY LIMITED TO REPAIR OR REPLACEMENT AS EXPRESSLY STATED IN THIS LIMITED WARRANTY. YOUR OFFICIAL OMEGA DEALER CARRIES SOLE RESPONSIBILITY FOR ANY OTHER GUARANTEES.

The OMEGA customer service ensures the perfect working order of your OMEGA watch. If your watch needs maintenance, rely on an official OMEGA dealer or an authorized OMEGA Service Center as set forth in the enclosed list: they can guarantee service according to OMEGA SA's standards.

*OMEGA SA
Rue Stämpfli 96, 2500 Bienne 4

©2002 OMEGA SA. All rights reserved.

OMEGA® and  are registered trademarks

OMEGA International Warranty

Your OMEGA® watch is warranted by OMEGA SA* for a period of twenty-four (24) months, thirty-six (36) months for watches with a Co-Axial Escapement, from the date of purchase under the terms and conditions of this warranty. The international OMEGA warranty covers material and manufacturing defects existing at the time of delivery of the purchased OMEGA watch (“defects”). The warranty only comes into force if the warranty certificate is dated, fully and correctly completed and stamped by an official OMEGA dealer** (“valid warranty certificate”).

During the warranty period and by presenting the valid warranty certificate, you will have the right to have any defect repaired free of charge. In the event that repairs are unable to restore the normal conditions of use of your OMEGA watch, OMEGA SA guarantees its replacement by an OMEGA watch of identical or similar characteristics. The warranty for the replacement watch ends twenty-four (24) months, thirty-six (36) months for watches with a Co-Axial Escapement, after the date of purchase of the replaced watch.

This manufacturer’s warranty does not cover:

- the life of the battery;
- normal wear and tear and aging (e.g. scratched crystal; alteration of the colour and/or material of non metallic straps and chains, such as leather, textile, rubber);
- any damage on any part of the watch resulting from abnormal/abusive use, lack of care, negligence, accidents (knocks, dents, crushing, broken crystal, etc.), incorrect use of the watch and non-observance of the use directions provided by OMEGA SA;

OMEGA International Warranty

10

- indirect or consequential damage of any kind resulting from e.g. the use, the non-functioning, the defects or the inaccuracy of the OMEGA watch;
- the OMEGA watch handled by non-authorized persons (e.g. for battery replacement, service or repair) or which has been altered in its original condition beyond OMEGA SA's control.

Any further claim against OMEGA SA e.g. for damages additional to the above described warranty is expressly excluded, except mandatory statutory rights the purchaser may have against the manufacturer.

The above manufacturer's warranty:

- is independent of any warranty that may be provided by the seller, for which he carries sole responsibility;
- does not affect the purchaser's rights against the seller nor any other mandatory statutory rights the purchaser may have against the seller.

The OMEGA customer service ensures the perfect maintenance of your OMEGA watch. If your watch needs attention, rely on an official OMEGA dealer or an authorized OMEGA Service Center as set forth in the enclosed list: they can guarantee service according to OMEGA SA's standards.

*OMEGA SA
Rue Stämpfli 96, 2500 Bienne 4

**OMEGA SA Specialist Dealer in EU Countries

OMEGA® and  OMEGA® are registered trademarks

CALIBRES 1376, 1456 (fig. II)

The crown has 2 positions:

1. **Normal position** (wearing position): when pushed into the case, the crown ensures that the watch is water-resistant.
2. **Time setting:** pull the crown out to position 2, turn the crown forwards or backwards. Push the crown back to position 1.

CALIBRES 1426, 1530, 1532 (fig. I)

The crown has 3 positions:

1. **Normal position** (wearing position): when pushed into the case, the crown ensures that the watch is water-resistant.
2. **Date setting:** pull the crown out to position 2, turn the crown forwards or backwards. Push the crown back to position 1.
3. **Time setting:** pull the crown out to position 3. The seconds hand will stop. Turn the crown forwards or backwards. Synchronise the seconds by pushing the crown back to position 1 to coincide with a given time signal.

CALIBRES 1424, 1538 (fig. I)

The crown has 3 positions:

1. **Normal position** (wearing position): when pushed into the case, the crown ensures that the watch is water-resistant.
2. **Time zone:** pull the crown out to position 2. Turn the crown forwards or backwards, the hour hand moves forwards or backwards in one-hour jumps. Push the crown back to position 1.

CALIBRES 1424, 1538 (continued)

Date setting: the date can be moved forwards or backwards by moving the hour hand past midnight accordingly. Push the crown back to position 1.

- Time setting:** pull the crown out to position 3. The seconds hand will stop. Turn the crown forwards or backwards. Synchronise the seconds by pushing the crown back to position 1 to coincide with a given time signal.

For calibres 1424, 1426, 1530, 1532 and 1538, the end of battery life is indicated by the seconds hand making 4-second jumps. The watch will continue to function for several days, but the battery must be removed and replaced by an authorised OMEGA service agent as soon as possible.

CALIBRE 4000 (fig. II_{bis})

This calibre does not have a visible crown. A corrector at 3 o'clock on the side of the case is used to change the time by simply pressing with a corrector pen that comes with the watch.

1. Time setting by pressing the corrector:

- Correcting the minutes: press briefly to advance the hand by one minute;
- Correcting the hours: press for around 3 seconds to correct by one hour. For corrections of more than one hour, hold until the desired hour is displayed.

Quartz chronograph

CALIBRE 1270 (fig. X)

The time functions (hours, minutes, seconds) are driven by a primary motor using traditional quartz watch technology.

The chronograph functions are provided by a combination of quartz and mechanical technology. The chronograph hand, driven by a separate motor, makes 16 jumps per second. Its movement appears continuous and it can be read off the scale to within 1/10th of a second. The reset function, like the minute and hour totaliser functions, is carried out mechanically. The return to zero is instantaneous.

In order to reduce energy consumption to a minimum, the chronograph automatically stops after more than 11 hours of operation.

The crown has 3 positions:

Watch functions:

1. **Normal position** (wearing position): when pushed into the case, the crown ensures that the watch is water-resistant.
2. **Date setting:** pull the crown out to position 2, turn the crown forwards until the required date is displayed, then push the crown back to position 1.

***NOTE:** it is impossible to set the date between 8pm and 2am.*

3. **Time setting:** pull the crown out to position 3. The seconds hand will stop. Turn the crown forwards or backwards. Synchronise the seconds by pushing the crown back to position 1 to coincide with a given time signal.

Chronograph functions:

- **Pusher A:** start – stop, start – stop etc. Timing to within 1/10th of a second for up to 11 hours.

Quartz chronograph

CALIBRE 1270 (continued)

- **Pusher B:** reset (after stopping).

Note:

Though the chronograph stops after 11 hours in order to conserve energy, it cannot be reset without pressing pusher A beforehand.

CALIBRE 5200

The hour, minute, second and chronograph functions are powered by 4 motors using conventional quartz technology.

The crown has three positions:

Watch functions:

1. **Normal position**, (wearing position): when pushed into the case, the crown guarantees the watch's water resistance.
2. **Time zone setting:** resetting the 30-minute totaliser.
3. **Time setting:** pull the crown out to position 3. The seconds hand will stop. Turn the crown forwards or backwards. Synchronise the seconds by pushing the crown into position 1 to coincide with a given time signal; resetting the 1/10th of a second and 60-second totalisers.

Chronograph functions:

Allows the time to be read off to 1/10th of a second up to 30 minutes in the simple, addition or split modes (reading split times).

Simple timing function
(crown in position 1):

- **Pusher A:** Start – stop (read time)
- **Pusher B:** Reset

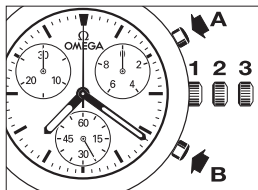

Quartz chronograph

Addition function (crown in position 1):

- **Pusher A:** Start
- **Pusher A:** Stop to read time
- **Pusher A:** Press again to restart
- **Pusher A:** Stop

At the end of the last step, the chronograph indicates the total time

- **Pusher B:** Reset

Split-time function (split seconds, crown in position 1):

- **Pusher A:** Start
- **Pusher B:** Stop to read the split time. The chronograph continues to operate.
- **Pusher B:** Restart

The chronograph hands catch up with the elapsed time.

- **Pusher A:** For the last stop and to display the total time
- **Pusher B:** Reset

ATTENTION: *The hands should be reset to their original position before the chronograph is used:*

- Initialisation of the 30-minute totaliser hand: Pusher B and crown in position 2;
- Initialisation of the 60-second totaliser hand: Pusher A and crown in position 3;
- Initialisation of the 1/10th of a second hand: Pusher B and crown in position 3.

Manual & Self-winding watch

CALIBRES 1120, 2500, 2520, 2610 (fig. I)

• 2627 (fig. III) • 2300 (fig. IX)

The crown has 3 positions, but only positions 1 and 3 are functional for cal. 1120 jewellery version (fig. IV).

16

1. **Normal position** (wearing position): when pushed into the case, the crown ensures that the watch is water-resistant.

Occasional winding: if the watch has not been worn for 44 hours or more, wind it up with the crown in position 1.

2. **Date setting:** pull the crown out to position 2, turn the crown backwards and push it back to position 1.

For calibre 2610 only: date adjustment is made by instantaneous jumps.

NOTE: date-setting is not recommended between 8pm and 2am.

3. **Time setting:** hours – minutes – seconds. Pull the crown out to position 3. The seconds hand will stop. Turn the crown forwards or backwards. Synchronise the seconds by pushing the crown back to position 1 to coincide with a given time signal.

Power reserve (cal. 2627)

Counter at 9 o'clock: small seconds.

Counter at 6 o'clock: power reserve indicator.

When the watch is fully wound, the power reserve indicator hand points to 4/4. This means that the power reserve is at least 44 hours.

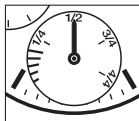

Manual & Self-winding watch

Power reserve (continued)

If the watch is not worn, or during periods of low activity, the power reserve indicator hand progressively moves anti-clockwise.

If the power reserve indicator hand is pointing to below 1/4, this means that the watch's power reserve is less than 10 hours. In this case, the watch should be worn or wound by hand to prevent it stopping.

During manual winding (crown in position 1) or when worn (self-winding), the power reserve indicator hand moves clockwise.

CALIBRES 2005 (fig. II) • 2200, 2201, 2202 (fig. VIII_{bis}) • 2403 (fig. VIII)

The crown has 2 positions:

1. **Normal position** (wearing position): when pushed into the case, the crown ensures that the watch is water-resistant. Occasional winding: if the watch has not been worn for 44 hours or more, wind it up with the crown in position 1.

CALIBRE 2201 (Manual-winding)

Winding: turn the crown forwards until it stops.

2. **Time setting:** hours – minutes. Pull the crown out to position 2. Turn the crown forwards or backwards. Push the crown back to position 1.

For calibres 2200, 2202 and 2403: synchronise the seconds by pushing the crown back to position 1 to coincide with a given time signal.

Self-winding chronograph

CALIBRES 3205 (fig. XV) • 3220 (fig. XIII) •
3601 • 3602

The crown has 2 positions:

18

Watch functions:

1. **Normal position** (wearing position): when pushed into the case, the crown ensures that the watch is water-resistant.

Winding: if the watch has not been worn for 45 hours or more, wind it up with the crown in position 1.

2. **Time setting:** hours – minutes – seconds. Pull the crown out to position 2. The seconds hand will stop. Turn the crown forwards or backwards. Synchronise the seconds by pushing the crown back to position 1 to coincide with a given time signal.

Chronograph functions:

Pusher A: start – stop, start – stop etc.

Timing to 1/8th of a second for up to 12 hours.

Pusher B: reset (after a stop).

Regatta function (cal. 3602)

Based on a 10-minute start period, as used in the America's Cup.

In addition to the counters for seconds, minutes and hours, this movement has an indicator that displays the countdown to a regatta start. This indicator operates simultaneously with the chronograph hands. Each circle on the display corresponds to 1 minute.



Self-winding chronograph

Regatta function (continued)

For a yacht race, the chronograph should be started at the warning signal by pressing pusher A. Once the 5 circles on the display have changed colour to blue, this means that 5 minutes have passed since the warning signal. Once the circles have changed to red, this means that 10 minutes have elapsed and that the starting line can be crossed.

NOTE: *If the chronograph function is stopped, the regatta function also stops, since the two functions are synchronised.*

Apnea function (cal. 3601)

Pusher A: start – stop, start – stop etc. Timing to 1/8th of a second.

Pusher B: reset (after a stop).

Apnea function based on a 14 minute dive:

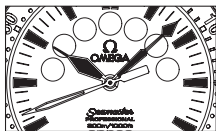

In addition to the hours and minutes hands, this movement has an indicator that displays the elapsed time of a dive. This indicator operates simultaneously with the chronograph seconds hand. Each circle on the display corresponds to 1 minute.

Before a dive, the chronograph should be started. Once the 7 circles on the display have changed to red, this means that 7 minutes have elapsed. Once the red colour has disappeared from the 7 circles this means that 7 more minutes have elapsed.

Self-winding chronograph with date

**CALIBRES 1151 (fig. XI) • 1152, 1164 (fig. XII)
• 3301, 3303, 3313 (fig. XIV) • 3304 (fig. XIX)**

The crown has 3 positions:

Watch functions:

1. **Normal position** (wearing position): when pushed into the case, the crown ensures that the watch is water-resistant.

Winding: if the watch has not been worn for 45 hours or more, wind it up with the crown in position 1.

2. **Date setting:** pull the crown out to position 2, turn the crown forwards (backwards for cal. 1151), then push the crown back to position 1.

NOTE: the date cannot be corrected between 9pm and 12.30am or 4am (cal. 1151).

CALIBRE 3304 (fig. XIX)

Changing the date: press the corrector C at 10 o'clock.

CALIBRE 1151 (fig. XI)

Date setting: pull the crown out to position 2, turn the crown backwards, then push the crown back to position 1.

Changing the day: press the corrector C at 10 o'clock.

Changing the month: automatic each time the date hand passes 31.

3. **Time setting:** hours – minutes – seconds. Pull the crown out to position 3. The seconds hand will stop. Turn the crown forwards or backwards. Synchronise the seconds by pushing the crown back to position 1 to coincide with a given time signal.

Chronograph functions:

Pusher A: start – stop, start – stop etc. Timing to 1/8th of a second for up to 12 hours.

Pusher B: reset (after a stop).

Self-winding split seconds chronograph

CALIBRE 3600 (fig. XVII) • 3612 (fig. XVIII)

Watch functions (calibre 3600)

The crown has 2 positions:

1. **Normal position** (wearing position): when pushed into the case, the crown ensures that the watch is water-resistant.
2. **Time setting:** hour – minutes – seconds. Pull the crown out to position 2. The seconds hand will stop. Turn the crown forwards or backwards. Synchronise the seconds by pushing the crown back to position 1 to coincide with a given time signal.

Watch functions (calibre 3612)

The crown has 3 positions:

1. **Normal position** (wearing position): when pushed into the case, the crown ensures that the watch is water-resistant.
2. **Date setting:** pull the crown out to position 2, turn the crown backwards, then push the crown back to position 1.
NOTE: the date cannot be corrected between 9pm and 12.30am.
3. **Time setting:** hours – minutes – seconds. Pull the crown out to position 3. The seconds hand will stop. Turn the crown forwards or backwards. Synchronise the seconds by pushing the crown back to position 1 to coincide with a given time signal.

Occasional winding: if the watch has not been worn for 45 hours (cal. 3600) or 55 hours (cal. 3612) or more, wind it up with the crown in position 1.

Chronograph functions:

Pusher A: start – stop, start – stop etc.

Timing to within 1/8th of a second for up to 12 hours.

Pusher B: reset (after a stop).

Self-winding split seconds chronograph

Chronograph functions with split seconds:

The split-seconds function allows split times to be recorded whilst the chronograph is running.

22

1. Start the chronograph by pressing pusher A (start).
2. To record a split time, press pusher C. The split-seconds hand D stops, indicating the split time, whilst the chronograph continues running.

NOTE: *The split time should be read immediately, since the chronograph totalisers for hours G, minutes E and seconds F continue to measure the elapsed time.*

For calibre 3600 only: Whilst the chronograph is running, do not leave the split-seconds hand D stopped any longer than is necessary to read the split time, otherwise the functioning of the split-seconds mechanism may be affected.

3. Press pusher C for the split-seconds hand to catch up with the chronograph seconds hand F.
4. To record a new split time, start from step 2 above.
5. Press pusher A to stop the chronograph.
6. Press pusher B to reset.

NOTE: *The split-seconds hand D must have caught up with the chronograph seconds hand F, as explained in step 3 above, before the chronograph is reset.*

Manual-winding chronograph

CALIBRES 1861, 1863 (fig. XV) • 1866, 3604 (fig. XVI)

The crown has 2 positions:

Watch functions:

1. **Normal position** (wearing position): when pushed into the case, the crown ensures that the watch is water-resistant.

Winding: turn the crown forwards until it stops.

2. **Time setting:** hours – minutes – seconds. Pull the crown out to position 2. Turn the crown forwards or backwards. Synchronise the seconds by pushing the crown back to position 1 to coincide with a given time signal.

Chronograph functions:

Pusher A: start – stop, start – stop etc. Timing to 1/6th of a second for up to 12 hours.

Pusher B: reset (after a stop).

Manual-winding chronograph

CALIBRE 1866–Date and moon phase correction

Date setting (small counter at 12 o'clock): press corrector C.

24

Setting the moon phase: press corrector D to move the disc into the full-moon position. Then determine how many days have elapsed since the last full moon (consult a calendar) and press the corrector the equivalent number of times.

When the watch is running, the date and moon phase move forward automatically.

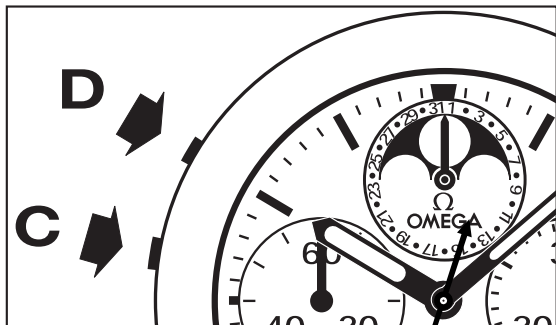

Important:

Avoid pressing correctors C and D (date and moon phase) if the watch is displaying any time between 7 and 12 o'clock (am or pm).

Do not set the date by moving the hour hand past midnight, since this may desynchronise the date and moon phase indicators.

CALIBRE 1680 (fig. V)

The particularity of the Gregorian calendar is that one day (29th February) is added to the year every four years to compensate for the length of the solar year, which is 365.242192 days, or almost 365 1/4 days. Such years are called leap years and their number (e.g. 1996) is divisible by 4.

As the compensation of one day every four years is too much, every 100 years (2100, 2200, ...) the year is not a leap year, even though it is divisible by four. However, even this is not totally sufficient, since it leaves an error of one day every 400 years. Therefore, if the number of the year is divisible by 400 it is a leap year, as was the case with the year 2000. Because of this, the perpetual calendar of your watch is set to function correctly until 2100.

Thermocompensation

This movement is 10 times more precise than a conventional quartz movement thanks to an electronic module that compensates for the effects of temperature on the movement's operation.

The crown has 3 positions:

Watch functions:

1.1. **Neutral position 1**, normal when the watch is worn: in this position, the crown ensures that the watch is water-resistant.

1.2. **Setting the hands: minutes and seconds.**

Pull the crown out to position 3 when the second hand is at 12 o'clock. The seconds hand will stop. Turn the crown forwards or backwards to set the minute hand.

Push the crown back into position 1 to coincide with a given time.

NOTE: To avoid inadvertently changing the date when setting the time, it is important to always follow point 1.2 and then point 1.3.

Perpetual calendar

1.3. Setting the date and hour hands:

Pull the crown out to position 2.

Then turn the crown: the hand moves in 1-hour jumps. If it is necessary to correct the date, (A), continue to turn the crown and the date will change automatically when switching from AM to PM, or the contrary, depending on the direction the crown is turned. Then push the crown back to position 1.

Important:

When setting the date, it is essential to check the date. If need be, pass midday (no date change) or midnight (date changes) to make sure the time is set in AM or PM as appropriate.

NB: Corrections in position 3 have no effect on the date, even if the hour hand passes midday or midnight. The watch stores the date in its memory (including whether AM or PM) before the time is reset. Setting the hours, minutes and seconds, around midnight and midday may therefore result in the calendar shifting by 12 hours.

2. Checking and correcting the calendar: month, yearly cycle and date.

2.1. Display and correction of the month.

Press and hold the crown in position 0 for more than 3 seconds, the month will be displayed for 8 seconds, (B). 1 = January, 2 = February, ..., 12 = December. The month can be corrected during these 8 seconds. Pull the crown out to position 2, turn the hour hand through one full revolution. The month will move forwards or backwards.

Repeat the procedure until the required month is displayed, then put the crown back to position 1.

Perpetual calendar

2.2. Display and correction of the yearly cycle.

Following display of the month (cf. 2.1.), the calendar continues to function and the year cycle is displayed in Roman numerals for 8 seconds, (C).

I = leap year +1 Example: 2005, 2009, 2013

II = leap year +2 Example: 2006, 2010, 2014

III = leap year +3 Example: 2007, 2011, 2015

IV = leap year Example: 2004, 2008, 2012

During these eight seconds, you can adjust the year cycle. To do so, pull the crown out to position 2, turn the hour hand through one full revolution. The year cycle will move forwards or backwards.

Repeat the procedure until the required yearly cycle is displayed. Push the crown back to position 1.

The calendar continues to function and displays the date, A.

See point 1.3. for how to correct the date.

2.3. Changing the time zone or daylight saving time:

Pull the crown out to position 2 and turn it. Only the hour hand will move forwards or backwards, without affecting the minutes or seconds. Push the crown back to position 1.

NOTE:

The end of battery life is indicated by the seconds hand making 4-second jumps. The watch will continue to function for several days, but the battery must be removed and replaced by an authorised OMEGA service agent as soon as possible. Once the watch stops, a memory function stores the date for one month.

Self-winding GMT & GMT Chronograph

28

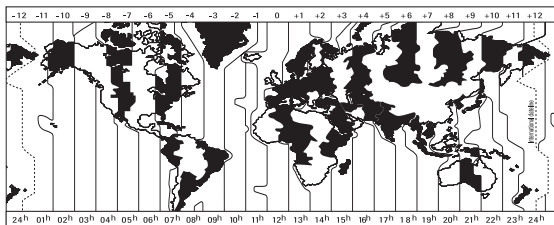

People travelling East, for example from London to Hong Kong, should pull the crown out to position 2 and move the hour hand forwards (in this case by 8 hours). The table above can be used to calculate any time difference.

People travelling West, for example from London to New York, should pull the crown out to position 2 and move the hour hand backwards (in this case by 5 hours). The table above can be used to calculate any time difference.

In both cases, the “24-hour” hand allows travellers to read the time back home – London, in our example – at a glance, using the 24-hour scale on the dial. The second time zone – in this case Hong Kong or New York – is read off the dial in the usual way.

Each time the hour hand crosses midnight, the date jumps forwards or backwards, depending on whether the hour hand is moved forwards or backwards.

CALIBRES 1128 (fig. VI) • 2628 (fig. VII)
• 3603 (fig. XX)

The crown has 3 positions:

1. **Normal position** (wearing position): when pushed into the case, the crown ensures that the watch is water-resistant.

Self-winding GMT & GMT Chronograph

Occasional winding: if the watch has not been worn for 44 hours (cal. 1128, 2628) or 55 hours (cal. 3603) or more, wind it up with the crown in position 1.

2. **Setting the time zone:** pull the crown out to position 2 and turn it. Only the hour hand moves (clockwise or anticlockwise), without affecting the precision of the minutes or seconds. If the hand moves past midnight, the date changes automatically. Push the crown back to position 1.

Setting the date: pull the crown out to position 2, turn it forwards or backwards to change the date each time the hour hand passes midnight. The date moves forwards (or backwards) one day. Repeat until the required date is obtained. Push the crown back to position 1.

Synchronisation of the hour hand and the "24-hour" hand (calibre 1128, fig. VI)

The triangle on the rotating bezel must point to 12 o'clock on the dial.

Pull the crown out to position 2 and turn it to synchronise the hour hand with the time indicated by the "24-hour" hand on the 24-hour scale on the rotating bezel. Make sure you set the hour hand in the correct half of the day! Push the crown back to position 1.

Synchronisation of the hour hand and the "24-hour" hand (calibre 2628, fig. VII, calibre 3603, fig. XX)

Pull the crown out to position 2 and turn it to synchronise the hour hand with the time indicated by the "24-hour" hand on the 24-hour scale in the centre of the dial. Make sure you set the hour hand in the correct half of the day!

After synchronising the hour hand with the "24-hour" hand, you must set the local time on your watch. Push the crown back to position 1.

Self-winding GMT & GMT Chronograph

- Setting the time:** hours – minutes – seconds. Pull the crown to position 3. The seconds hand will stop. Turn the crown forwards or backwards. Synchronise the seconds by pushing the crown back to position 1 to coincide with a given time signal.

SECOND TIME ZONE (calibre 1128, fig. VI)

Thanks to the “24-hour” hand with its triangular point, travellers can read the time back home at a glance on the 24-hour scale on the rotating bezel. In order to do so, the triangle on the bezel must point to 12 o’clock on the dial.

The bi-directional turning bezel (calibre 1128)

allows a third time zone to be read. To do so, the bezel must be turned so that the “24 hour” hand points to this third time zone on the bezel. When read off against the scale on the bezel, the “24 hour” hand will then indicate the time in this third time zone.

In order to read the time back home, the triangle of the bezel must be returned to point to 12 o’clock on the dial.

SECOND TIME ZONE (calibre 2628, fig. VII, calibre 3603, fig. XX)

Thanks to the “24-hour” hand with its triangular point, travellers can read the time back home at a glance on the 24-hour scale at the centre of the dial.









CHRONOGRAPH FUNCTIONS (calibre 3603, fig. XX)

- **Pusher A:** start – stop, start – stop, etc. Timing to within 1/10th of a second for up to 11 hours.
- **Pusher B:** reset (after stopping).

Omega mechanical watches with a certified chronometer movement

Omega watches bearing the chronometer inscription (in accordance with the certificate issued by your authorised Omega retailer) are high-precision timepieces that have passed the precision tests of the Official Swiss Chronometer Testing Institute (*Contrôle Officiel Suisse des Chronomètres, COSC*).

This neutral and independent body individually tests each movement for 360 consecutive hours, during which it is placed in the five common wrist positions and exposed to three different temperatures.

Days	1,2	3,4	5,6	7,8	9,10
Position					
Temperature	23°C	23°C	23°C	23°C	23°C
Days	11	12	13	14,15	
Position					
Temperature	8°C	23°C	38°C	23°C	

To earn the title of chronometer, the mechanical movement's average daily variation in rate must be between $-4/+6$ seconds per day, or a precision of 99.99%, the highest precision attainable by a mechanical movement.

The precision of a mechanical movement depends on the individual habits of the wearer and can therefore vary. A qualified Omega watchmaker can adjust the precision of a watch to within the Omega tolerances, which are from -1 to +6 seconds per day.

Other Omega mechanical watches

The majority of watches that do not have a chronometer certificate have average precision tolerances of between -1 and +11 seconds per day.

The precision of a mechanical movement depends on the individual habits of the wearer and can therefore vary. A qualified Omega watchmaker can adjust the precision of a watch to within the Omega tolerances.

Quartz watches

All Omega quartz movements are produced in accordance with Omega's highly renowned procedures and quality standards. Ambient temperature may affect the precision of quartz movements, which can lead to variations of between -0.5 and +0.7 seconds per day.

Quartz watches with thermocompensation (calibre 1680)

This movement is fitted with an electronic module that compensates for the effects of temperature on the movement's precision. These watches are accurate to within +/- 0.055 seconds per day.

The precision of a mechanical watch cannot be compared to that of a quartz watch, given that the two are based on different technologies.

Helium escape valve

Your OMEGA Seamaster Professional Diver is the watch for professional and amateur divers, as well as demanding sportsmen and –women. A robust design, the new helium escape valve (exclusive OMEGA patent), together with all the protection systems, offer optimal security and reliability. In order to ensure that your watch remains watertight, we recommend that you have it checked by an authorised OMEGA partner every year.

Helium escape valve (fig. 1)

Why a helium escape valve? Air cannot be used for deepsea dives, since nitrogen (a constituent element of air) becomes toxic at a depth of 60 metres. Therefore, when carrying out work at great depths, professional divers stay in a diving bell for several days, breathing a mixture of gases containing a high proportion of helium. The pressure is gradually increased to reach the pressure at the working depth. The divers, still inside the bell, are then lowered to the working site. They leave the bell to carry out their work.

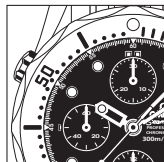

fig. 1

Once their work is complete, they re-enter the bell, which is then raised to the surface. Pressure is then returned to atmospheric levels and this is when the valve must be opened (only for deepsea dives lasting several days).

The helium molecules diffuse and penetrate the material of the gaskets. The quantity is sufficient to push out the crystal during the return to atmospheric pressure. To avoid this, the Seamaster Professional Diver is equipped with a valve specially developed by OMEGA.

Helium escape valve

How to use the helium escape valve (fig. 2)

In its normal position (fig. 2.1), the OMEGA helium escape valve is perfectly watertight thanks to gasket (B), but it is not functional, since it is screwed in.

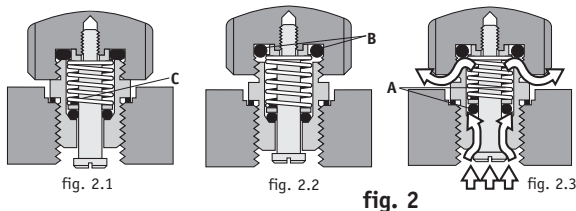

During the decompression phase, unscrew the crown of the valve in order to release the mechanism (fig. 2.2). The valve is now watertight from the outside. As the interior pressure becomes greater than the exterior pressure, it pushes the gasket A out of its seating, thus releasing the gas (fig. 2.3). Once the pressure is equalised, gasket A returns to its original position, pushed by the spring C (fig. 2.2).

This operation is automatically repeated several times during the decompression phase. Once atmospheric pressure is reached, screw in the crown of the valve (fig. 2.1).

Note:

Even if the valve is unscrewed, the watch is still water resistant to 50 metres. However, complete water resistance is guaranteed by gasket (B) when the valve is screwed in.

Tachymetric scale

To read the time, the position of the central seconds hand is used. For observations over longer periods, the indications of the totalisers (hours and minutes) are also used.

35

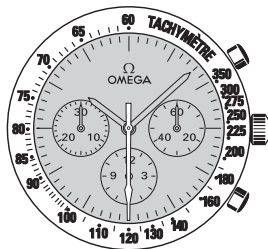

Using the tachymetric scale

Example: calculating the speed of a car.

Record the time the car takes to cover a distance of 1 kilometre. Read off the speed on the tachymetric scale indicated by the central seconds hand. In this case, the car is travelling at 120 km/hr.

Rubber strap

For your own peace of mind and convenience, we recommend that you have the length and position of your rubber bracelet adjusted by an authorised OMEGA service centre.

36

When adjusting the length of the strap, the clasp should be set in its shortest position.

- 1) Measure the circumference of the wrist using the flexible measure, placing the blank end over the graduated part.

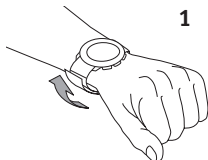

- 2) Remove the metal connectors from the clasp by pushing in the two spring pins.

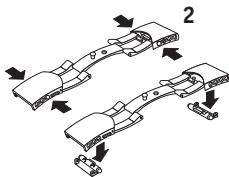

- 3) Cut off the two lengths below the figure corresponding to the number indicated on the flexible measure when the wrist was measured. If there is any doubt as to the exact measurement, it is preferable to cut at the upper graduation.

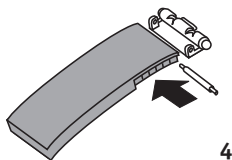
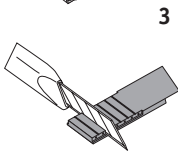

4

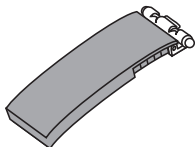

Rubber strap

- 4) Insert the two spring pins in the holes in the rubber and attach the metal connector.
- 5) Insert the rubber sections with the connectors fitted into the steel clasp by pushing in the two spring pins. The side marked OMEGA should face the skin.

37

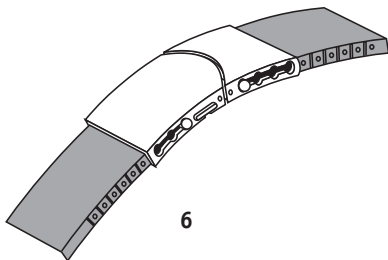
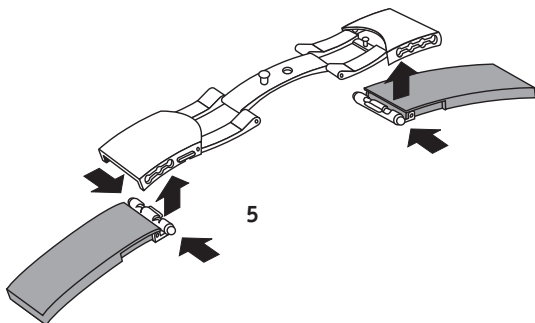

Foldover clasps

Only OMEGA leather straps, specially designed for this foldover clasp, should be used. For your own peace of mind and convenience, we recommend that you have your new clasp fitted by an authorised OMEGA service centre. You can always adjust the length of the bracelet yourself.

38

a) Snap-fastening foldover clasps

Opening

To open your clasp, simply slide your finger or finger nail under the OMEGA fastener and pull up firmly.

Closing (fig. 1, 2)

Place your OMEGA watch on your wrist and close the clasp by pushing with the thumb, as indicated in figure 1. Press in the direction of the arrow and not as indicated in figure 2.

fig. 1

fig. 2

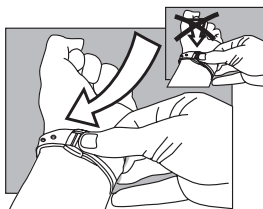

Adjusting the length (fig. 3, 4)

Free the longer section of the strap by removing the two studs from the holes (fig. 3). Adjust the strap as required and replace the two studs in the holes (fig. 4). Try the watch for size and readjust if necessary.

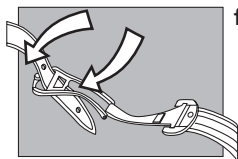

fig. 3

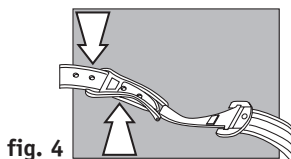

fig. 4

Foldover clasps

b) Foldover clasps with pushers

Opening (fig. 5)

To open the clasp, press the two pushers either side of the Omega buckle and pull upwards.

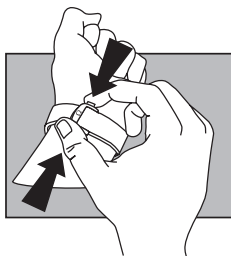

fig. 5

39

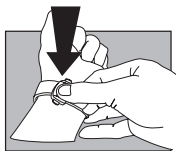

fig. 6

Closing (fig. 6)

Put the watch on your wrist and close the clasp by pushing on it with your thumb until you hear a click.

Adjusting the length (fig. 7)

Loosen the longer end of the strap from the two holders on the clasp and remove the stud from the perforation. Move the strap in the required direction, put the stud back in the perforation then adjust the bracelet under the two holders on the clasp. Try the watch for size and repeat if necessary.

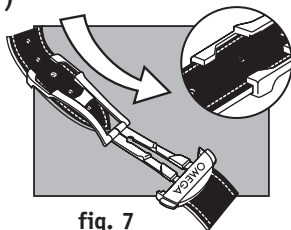































fig. 7

Pictograms

	Calibre number
	Co-Axial
	Self-winding
	Chronometer
	Manual-winding
	Ω-matic
	Quartz
	Easy Time Zone Change
	Power Reserve
	Tachymeter
	Split-seconds
	Perpetual Calendar
	Big date
	Thermocompensated movement
	End of battery life indicator
	Sapphire crystal
	Multi-layered anti-reflective treatment inside
	Double anti-reflective treatment inside and outside
	18-ct. gold
	Platinum
	Screw-in crown
	Helium escape valve
	Water-resistant to 30 metres/100 feet
	Water-resistant to 50 metres/167 feet
	Water-resistant to 100 metres/330 feet
	Water-resistant to 120 metres/360 feet
	Water-resistant to 150 metres/500 feet
	Water-resistant to 200 metres/660 feet
	Water-resistant to 300 metres/1000 feet
	Water-resistant to 600 metres/2000 feet
	Number of diamonds and carats



www.omegawatches.com